

About the D-10-EC-STD

The Designer Series 10-EC-230 is a suitable choice for ceiling heights up to 12 ft., providing an area of coverage of up to 500 sq. ft.

D-10-EC-STD Control Types

The D-10-EC-STD uses an electrically commutated (EC) motor and can be controlled with a 0-10VDC signal.



Velocity Profile

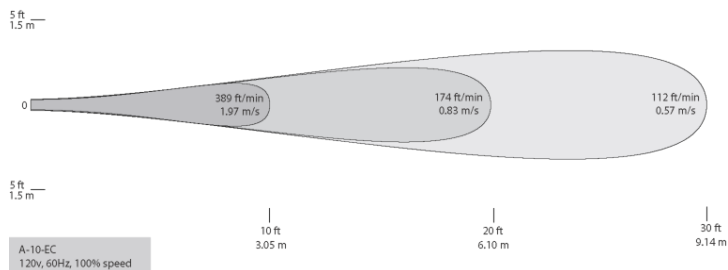

Data represents 80th percentile of 2000+ samples collected via hot wire anemometer recorded horizontally

Alternative Fan Models (Similar to D-10-EC-STD-200-250-W)

Alternative Body Styles: Air Pear, Designer Series, Suspended Series

Alternative Sizes: 10, 15, 25

Alternative Motors: EC, SP

Alternative Nozzles: STD, SH

Alternative Voltages: 120V, 230V

Alternative Colors: Off White, Custom

Contact

811 S. Sherman St., Longmont, CO 80501

Web: airiusfans.com

Phone: 888-AIR-PEAR (247-7327)

Fax: 303-772-8276

Product Description

Airius fans create uniform air temperatures from floor to ceiling for thermal comfort and energy savings.

Housing: Aluminum, 5VA flame resistance. Off White

Motor: Electrically commutated, thermally-protected axial motor by ebm-papst®, 92% efficient. Operating temperature: -22°F (-30°C) to 122°F (50°C)

Stator: Patented multi-vane stator significantly increases air throw for maximizing performance.

Certification: Conforms to UL-507, CAN/CSA-C22.2 No. 1113, UL 94 5VA and is ETL listed in USA and Canada

Warranty: 3 years parts and workmanship. Money back guarantee: 30 days. Refurbishment program after 3-year warranty period.

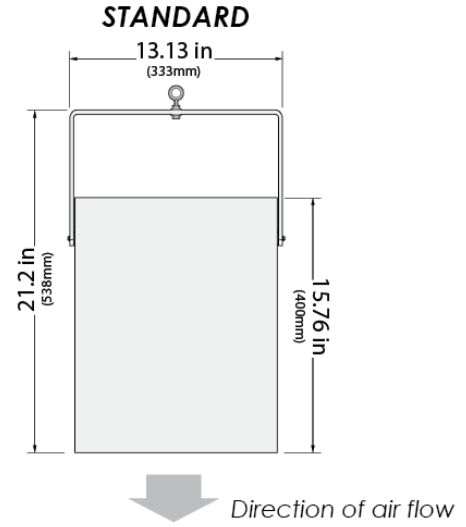

Maximum Ratings

Model	Input Power, 1Ø	Amps	Watts	RPM	dB(A)	Mounting Height	Coverage Area
D-10-EC-STD	200-250VAC, 60Hz	0.06	13.0	1000	58.0	Up to 12 ft.	Up to 500 sq. ft.

⁽¹⁾dB as Sound Power Level, designed to meet ISO 3744 - engineering grade precision for determining sound power. Data independently verified by third party. Tests performed in-unit.

Controls & Factory Installed Options

Item #	Description
EC-MOD	Required for 0-10V control of this fan. Incompatible with PHI cells.
Pearlink	Wi-Fi iOS/Android controller
POT-1	Wall-mounted speed control
PHI-9-C	9" Photohydroionization cell to mitigate mold, bacteria, viruses, and odors
GUARD25	Phosphated steel grille coated in black plastic

Fan Config: D-10-EC-STD-200-250-W	QTY:
Controls/Options:	QTY:
Project:	Engineer:
Submitted By:	Architect:
Date:	Contractor: