

About the D-15-SP-STD

The Designer Series 15-SP-230 is a suitable choice for ceiling heights up to 18 ft., providing an area of coverage of up to 800 sq. ft.

D-15-SP-STD Control Types

The D-15-SP-STD uses a shaded pole (SP) motor and can be controlled using a wall-mounted TRIAC speed control in-line with the fan power circuit or a 'smart' controller that accepts 0-10VDC, 2-20mA, or automatic Delta-T control signal.



Velocity Profile

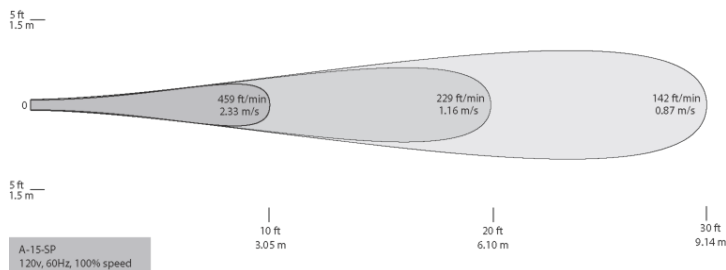

Data represents 80th percentile of 2000+ samples collected via hot wire anemometer recorded horizontally

Alternative Fan Models (Similar to D-15-SP-STD-230-W)

Alternative Body Styles: Air Pear, Designer Series, Suspended Series

Alternative Sizes: 10, 15, 25

Alternative Motors: EC, SP

Alternative Nozzles: STD, SH

Alternative Voltages: 120V, 230V

Alternative Colors: Off White, Custom

Contact

811 S. Sherman St., Longmont, CO 80501

Web: airiusfans.com

Phone: 888-AIR-PEAR (247-7327)

Fax: 303-772-8276

Product Description

Airius fans create uniform air temperatures from floor to ceiling for thermal comfort and energy savings.

Housing: Aluminum, 5VA flame resistance. Off White

Motor: Single phase, shaded pole, single/variable speed, thermally-protected axial motor. Operating temperature: -4°F (-20°C) to 158°F (70°C). No lubrication required. Bearings are sealed.

Stator: Patented multi-vane stator significantly increases air throw for maximizing performance.

Certification: Conforms to UL-507, CAN/CSA-C22.2 No. 1113, UL 94 5VA and is ETL listed in USA and Canada

Warranty: 3 years parts and workmanship. Money back guarantee: 30 days. Refurbishment program after 3-year warranty period.

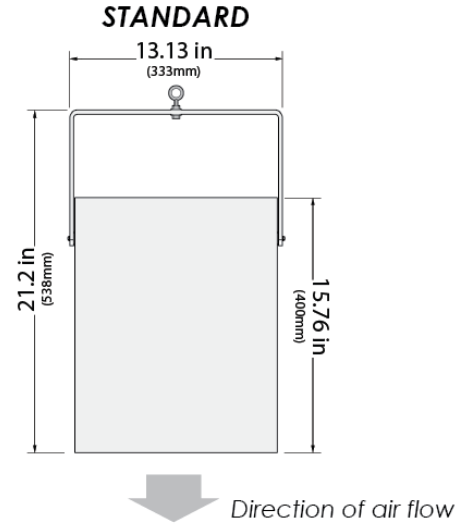

Maximum Ratings

Model	Input Power, 1Ø	Amps	Watts	RPM	dB(A)	Mounting Height	Coverage Area
D-15-SP-STD	230VAC, 60Hz	0.07	17.0	1260	47.3	Up to 18 ft.	Up to 800 sq. ft.

⁽¹⁾dB as Sound Power Level, designed to meet ISO 3744 - engineering grade precision for determining sound power. Data independently verified by third party. Tests performed in-unit.

Controls & Factory Installed Options

Item #	Description
TRIAC-SMART-7.5	0-10VDC, 2-20mA, or fixed speed. Max 107 fans.
TRIAC-SMART-7.5-AUTO	Temperature control, 0-10VDC, 2-20mA, or fixed speed. Max 107 fans.
TRIAC-230-8	230V, 8A TRIAC. Max 114 fans.
PHI-9-C	9" Photohydroionization cell to mitigate mold, bacteria, viruses, and odors
GUARD25	Phosphated steel grille coated in black plastic

Fan Config: D-15-SP-STD-230-W	QTY:
Controls/Options:	QTY:
Project:	Engineer:
Submitted By:	Architect:
Date:	Contractor: